



# REMIVER

Ingeniería, Técnica y Calidad a su Servicio

[WWW.REMIVER.COM](http://WWW.REMIVER.COM)

**REPSE**

No. REGISTRO: 261049





# CONTENIDO

01

Nosotros

02

Ubicación

03

Misión - Visión

04

Valores

05

Servicios

06

Galería

07

Clientes

08

Contacto



# NOSOTROS



REMIVER es una empresa pyme legalmente constituida en agosto 2011, dedicada a la prestación de diversos servicios de mantenimiento en el sector Industrial, Comercial y Residencial.



Nuestro equipo y experiencia a traves de premisas como: Técnica, Calidad y Compromiso, nos ha permitido contribuir en la industria de la Construcción para la gestion de proyectos de Arquitectura e Ingenieria, presentando soluciones sólidas ejecutadas en tiempo y forma.





CON PRESENCIA EN:

- Xalapa
- Cordoba
- Orizaba
- Tuxpan
- Minatitlán
- Coatzacoalcos
- Ciudad de México
- Puebla, Puebla
- Mérida, Yucatan
- Villahermosa, Tab



# UBICACIÓN

REMIVER S.A DE C.V



Zona conurbada  
Veracruz Boca del Río



Avenida Veracruz #427  
Col. Adolfo Ruiz Cortines  
IPE. CP 91829



[www.remiver.com](http://www.remiver.com)

# MISIÓN

Brindar diversos servicios de mantenimiento integral, Arquitectura y Construcción garantizando calidad a través de la dedicación y compromiso con el objetivo de satisfacer a nuestros clientes en el sector Industrial, Comercial y Residencial.

# VISIÓN

Ser una empresa mexicana líder con presencia nacional ofreciendo una amplia gama de soluciones en nuestro sector sustentado por nuestros valores y superando constantemente las expectativas.





# VALORES

Nuestra empresa forjada con los valores que nos representan, trabajando en un entorno de integridad y confianza.

COMPROMISO



CALIDAD



HONESTIDAD



RESPONSABILIDAD





# SERVICIOS

Presentando los diferentes sectores en los que nos desarrollamos de acuerdo a sus necesidades



MANTENIMIENTO INDUSTRIAL



ARQUITECTURA CONSTRUCCIÓN



SUMINISTROS DE MATERIALES



# MANTENIMIENTO INDUSTRIAL

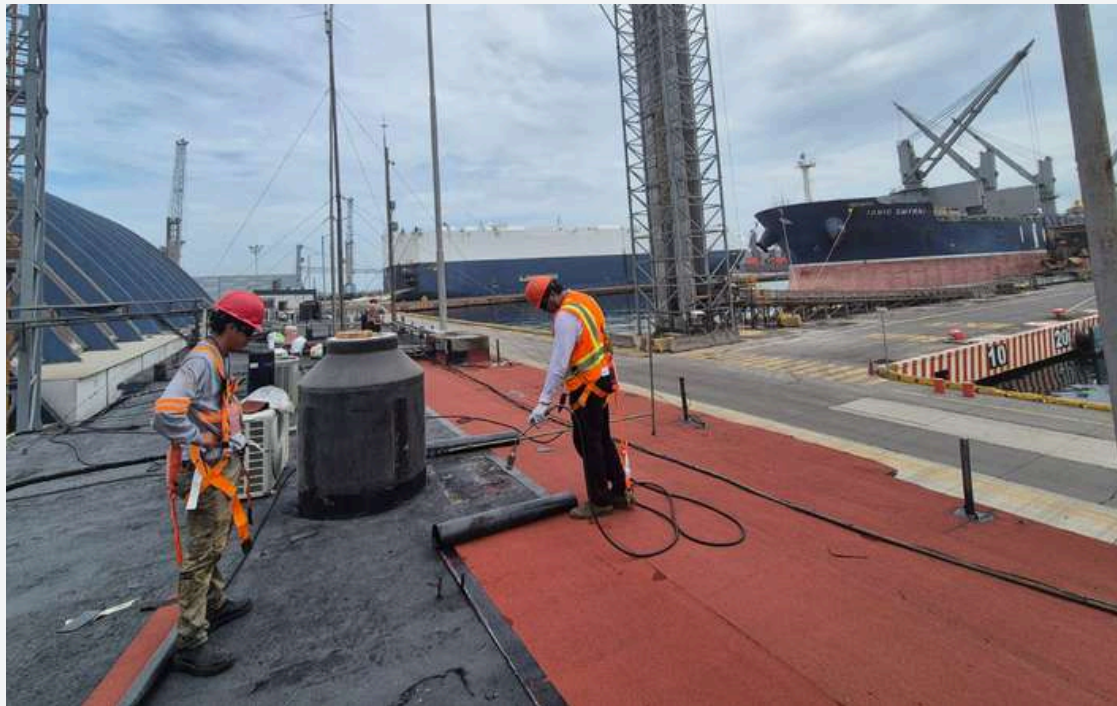

## 01 IMPERMEABILIZACIONES

- Acrílicos
- Prefabricados
- Asfálticos
- Cementosos

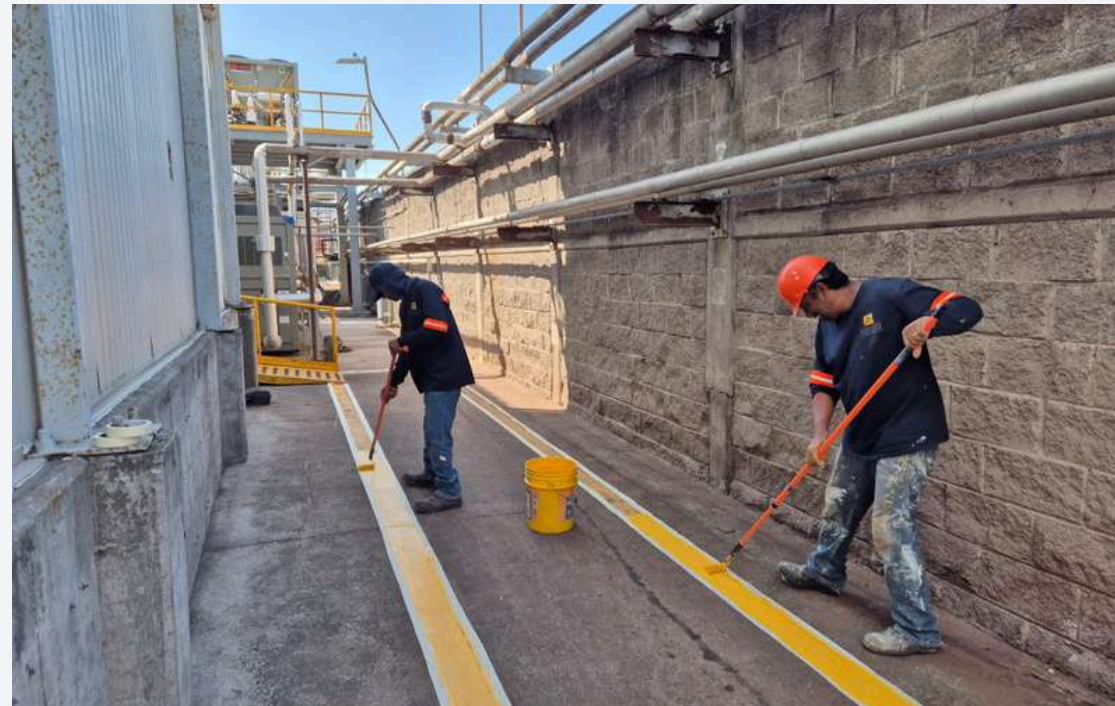

## 02 PINTURA

- Esmalte para estructuras
- Acrílicas
- Vinílicas
- Epóxicos



## 03 RECUBRIMIENTOS

- Aplanados
- Empastados
- Ceramicos/Porcelanatos
- Lambrines



# MANTENIMIENTO INDUSTRIAL



## 04 MANTENIMIENTO GENERAL

- Soldadura
- Aluminio
- Mantenimientos de estructuras metálicas
- Reparaciones generales



## 05 INSTALACIONES ELECTRICAS

- Canalizaciones
- Luminarias / Alumbrado
- Mantenimiento a equipos
- Revisiones preventivas



## 06 AIRES ACONDICIONADOS

- Instalaciones
- Mantenimiento preventivo y correctivo
- Reparaciones



# ARQUITECTURA / CONSTRUCCION

- Diseño y remodelaciones
- Lectura y elaboracion de planos / Modelado 3D
- Presupuestos de obra
- Levantamientos Arquitectonicos

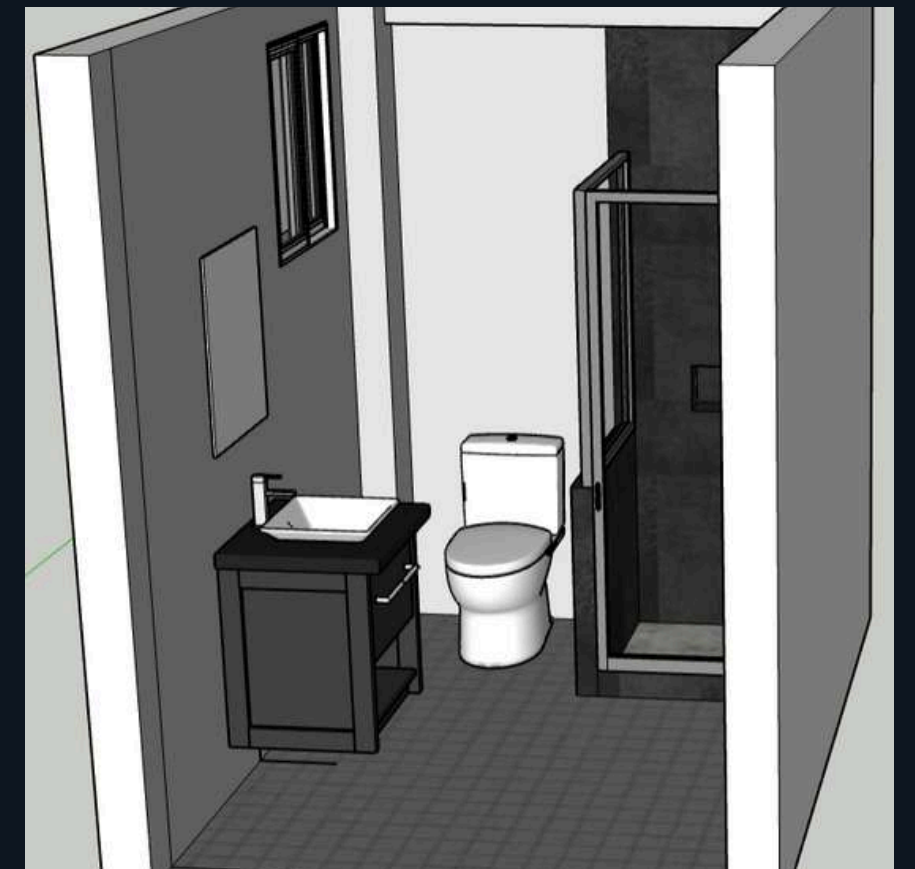
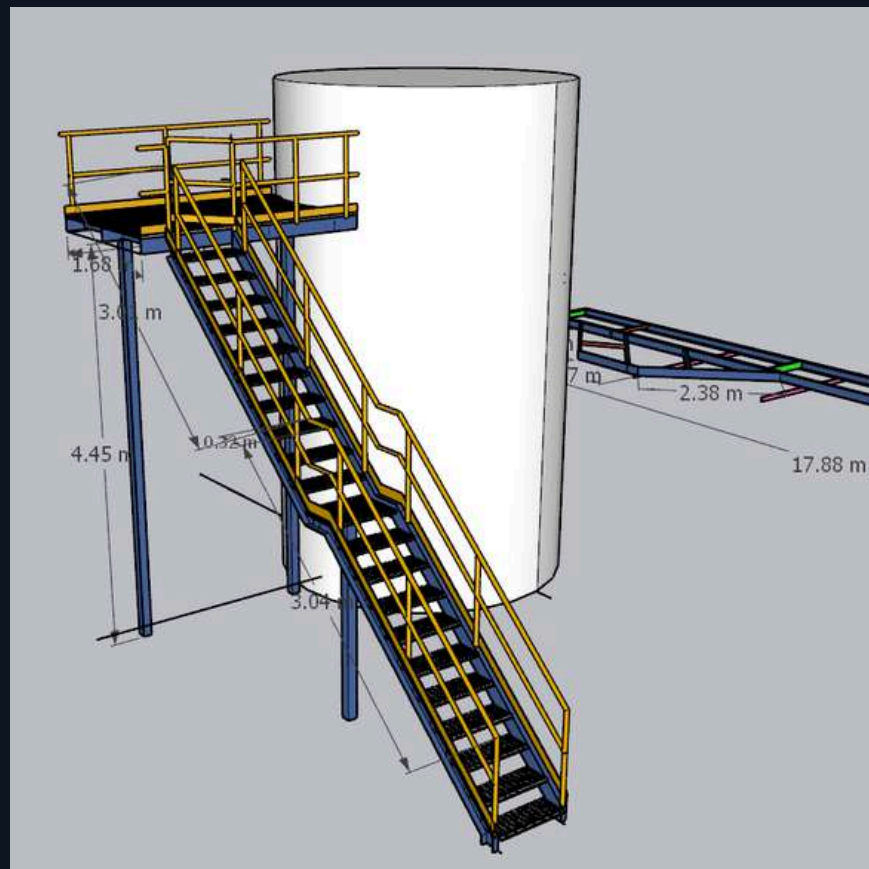
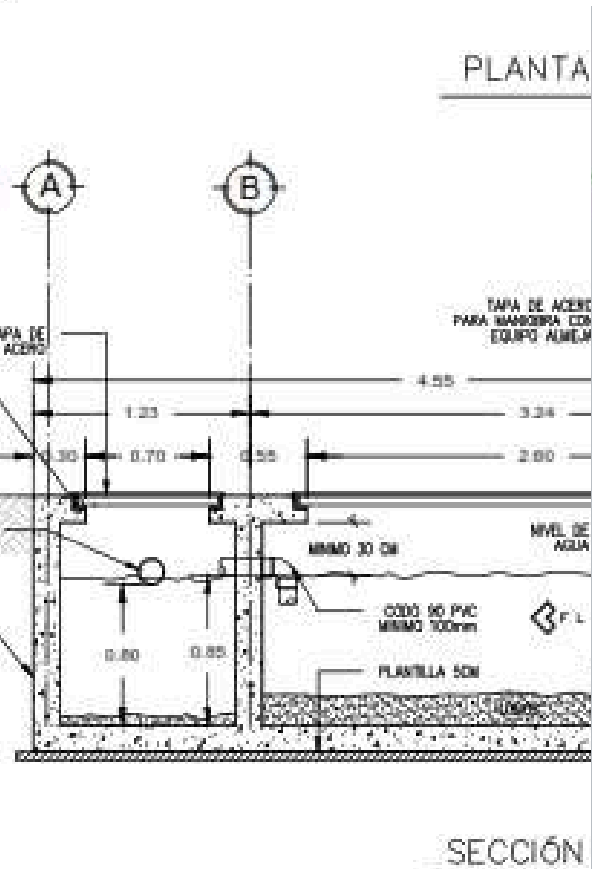
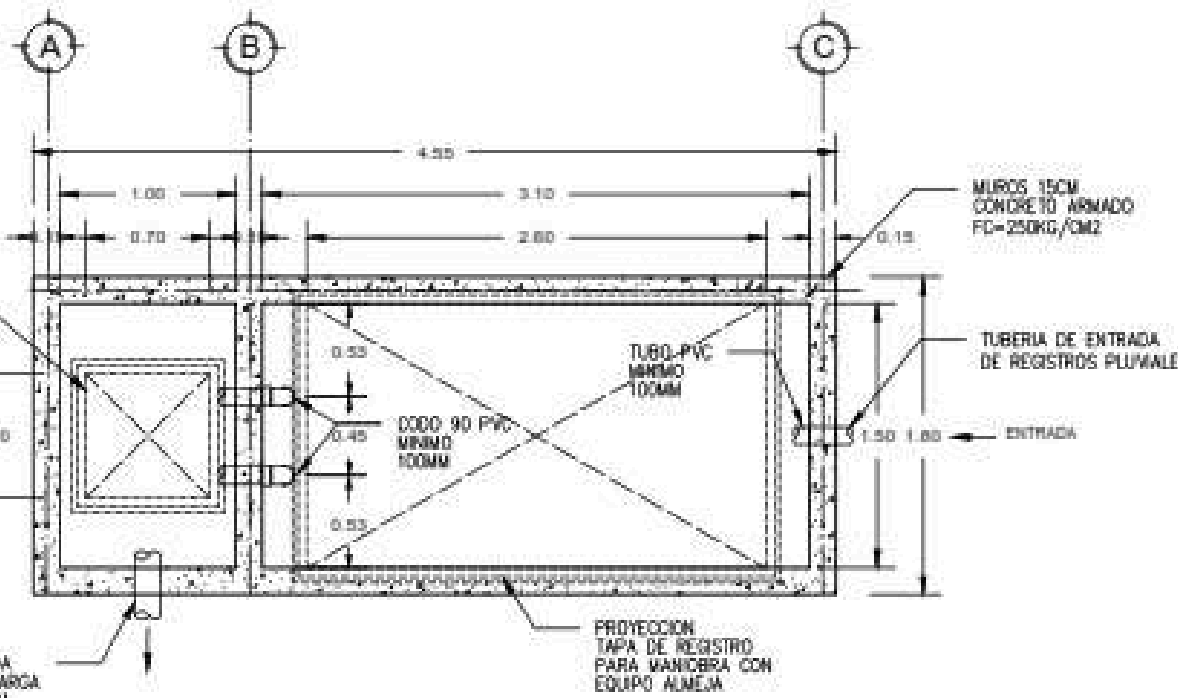

PROYECTO	ARQ. JOSE IVAN FERNANDEZ ALONSO CEDULA 1125448	PLANO:	PL 01
APROBADO	ING. GUSTAVO JACOB KOBAS		
CONTACTO	DIRECCION@REMIVER.COM www.remiver.com		
	AVENIDA VERACRUZ #427 CALLE AGUSTO RUIZ CONTRERAS VERACRUZ, VER C.P. 91735		

**REMIVER**  
Ingeniería, Técnica y Calidad a su Servicio

COTAR EN METROS



# SUMINISTRO DE MATERIALES

Siendo intermediarios entre proveedor y cliente final,  
facilitando la cadena de suministro



## CONSTRUCCIÓN

- Cemento
- Ladrillo, block
- Madera
- Varilla distintos calibres
- Tablaroca

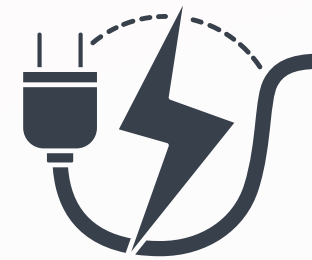

## ELÉCTRICO

- Cables conductores
- Lámparas
- Accesorios
- Tubería
- Terminales
- Equipos



## OTROS

- Pintura
- Aluminio
- Perfiles, ángulos
- Tubería y conexiones PVC
- Tuboplus y accesorios
- Refacciones y otros

Envío con paquetería, flete particular o L.A.B. Veracruz.



[www.remiver.com](http://www.remiver.com)

# SLOAN

## CENTRO TÉCNICO DE SERVICIO

SERVICIO DE VENTA, INSTALACIÓN Y MANTENIMIENTO

- Refacciones
- Producto terminado
- Especiales

CONSULTA TU ASESOR DE VENTA

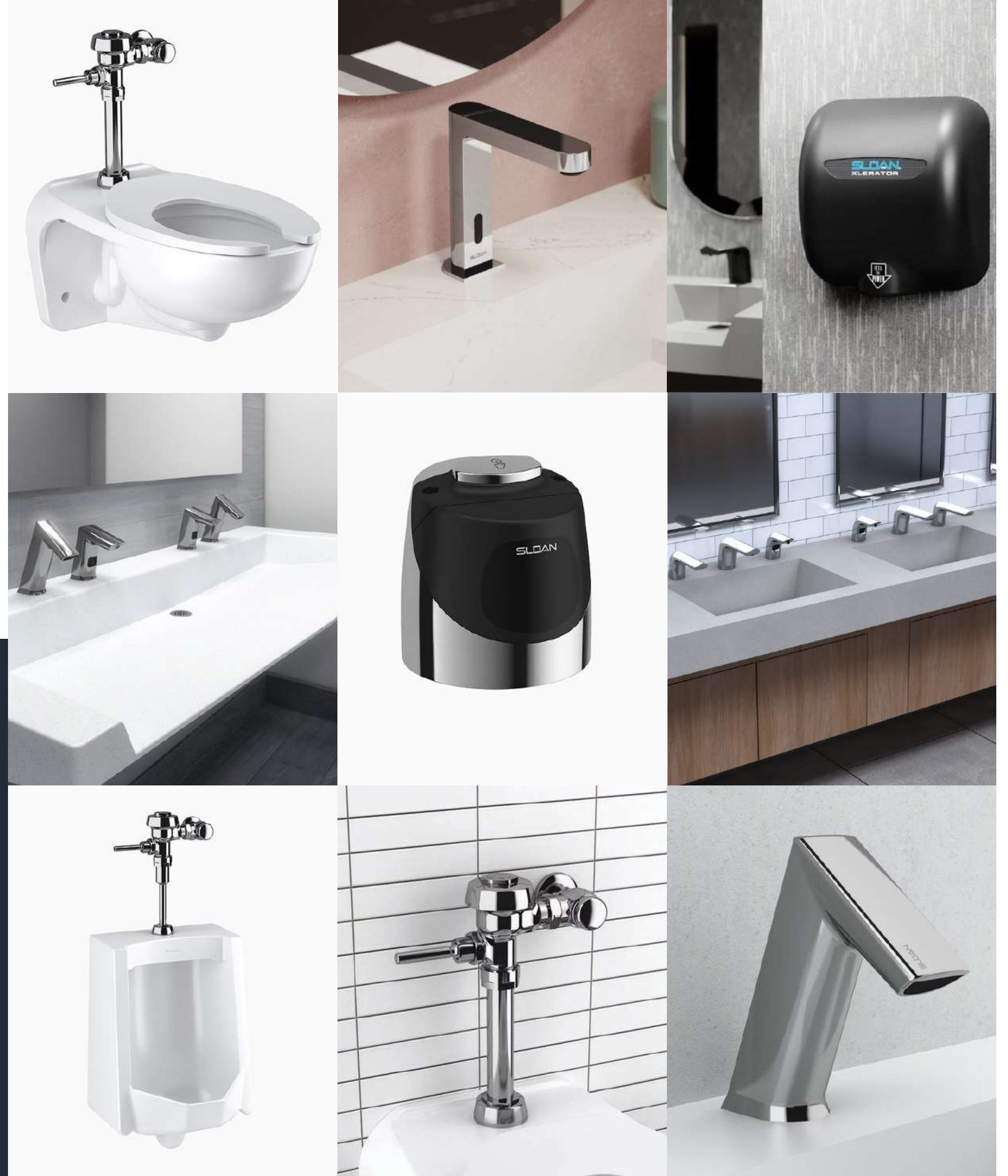

[www.remiver.com](http://www.remiver.com)

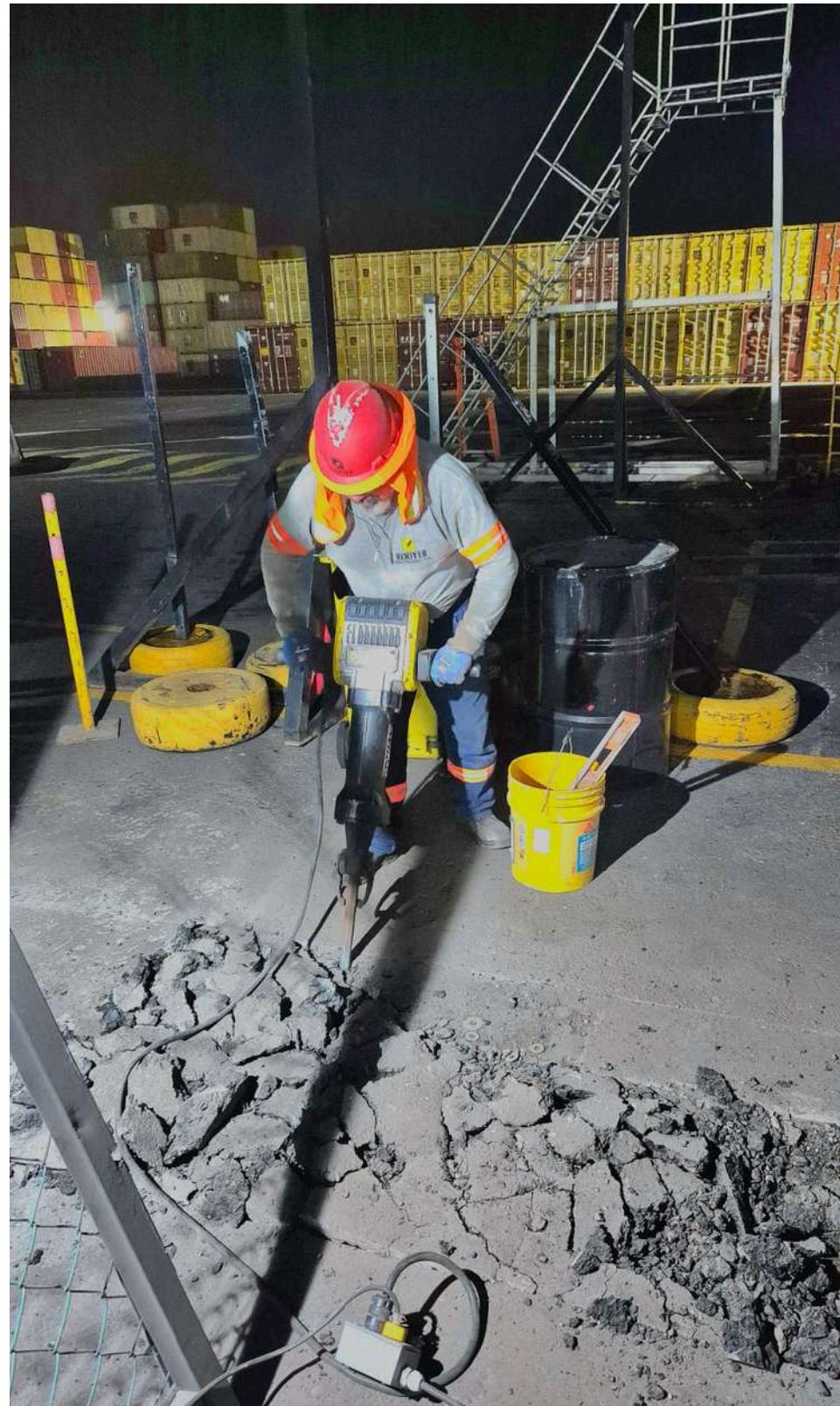

# REMIVER GALERIA





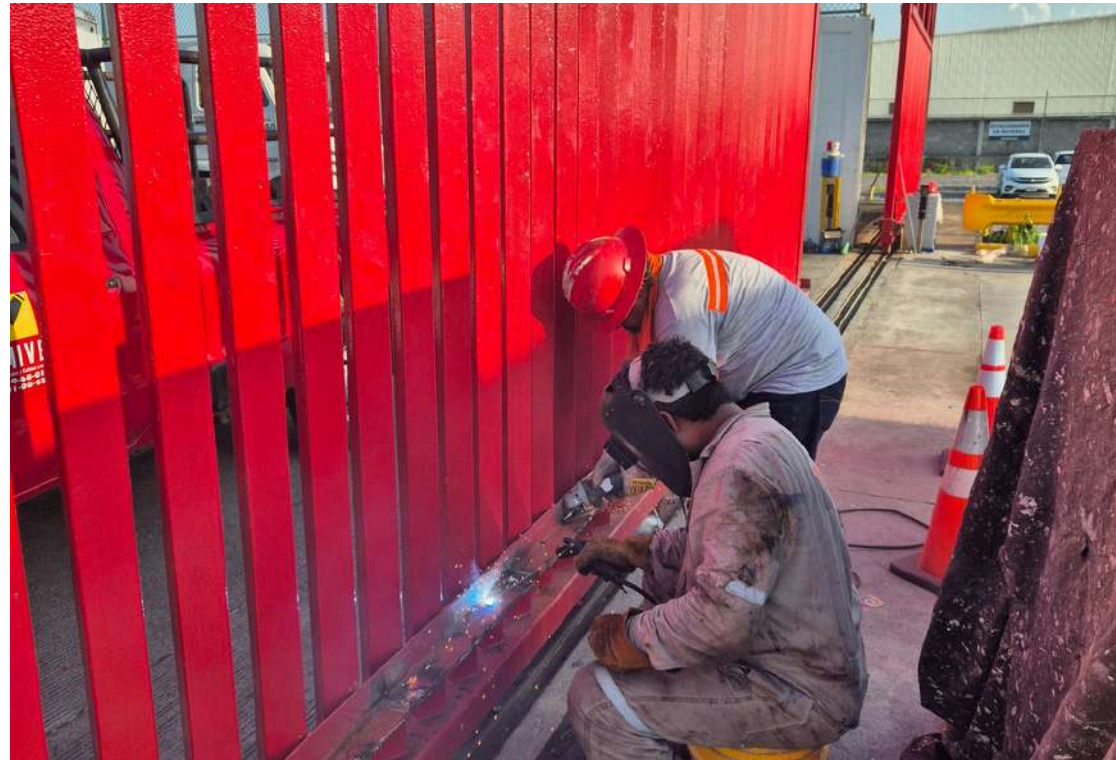
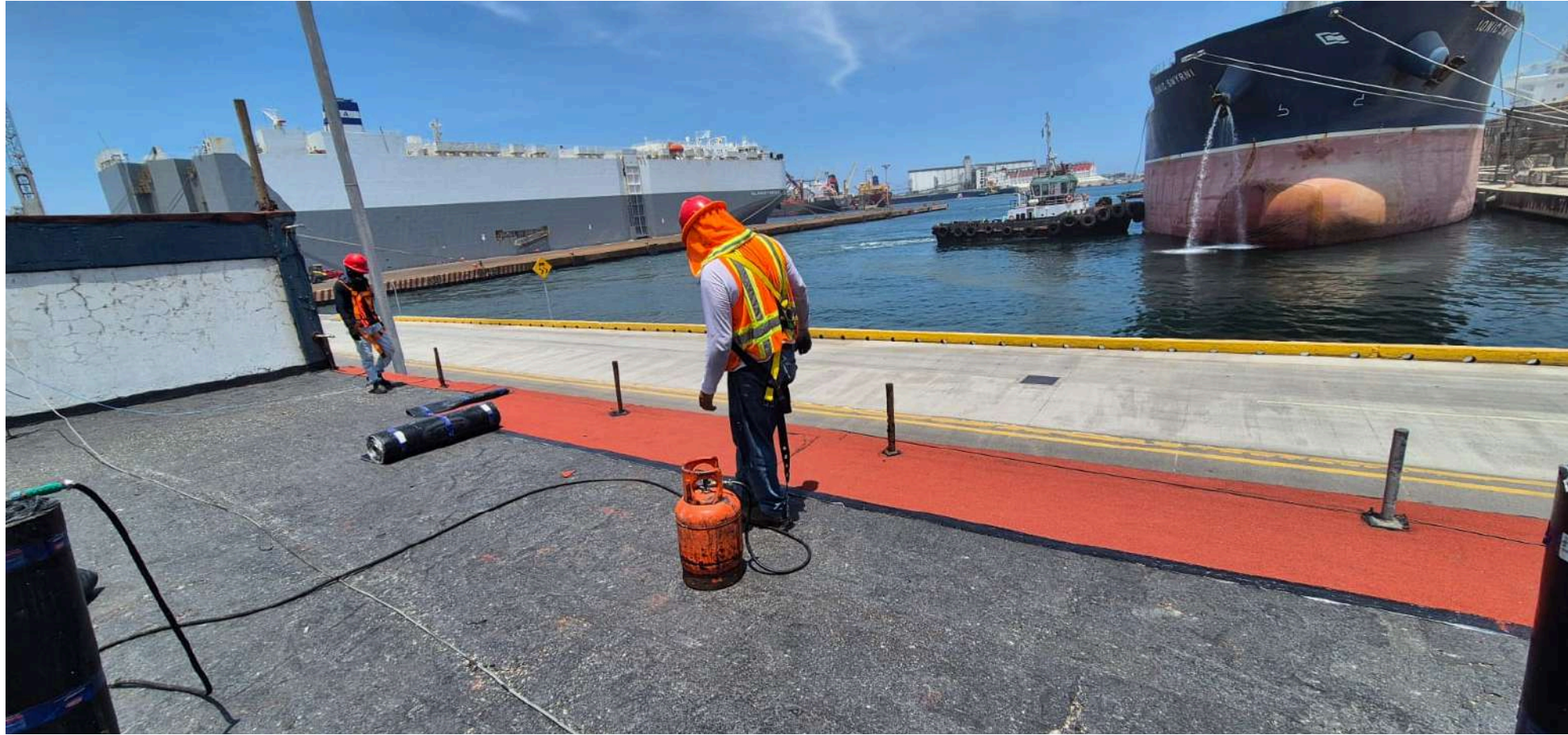

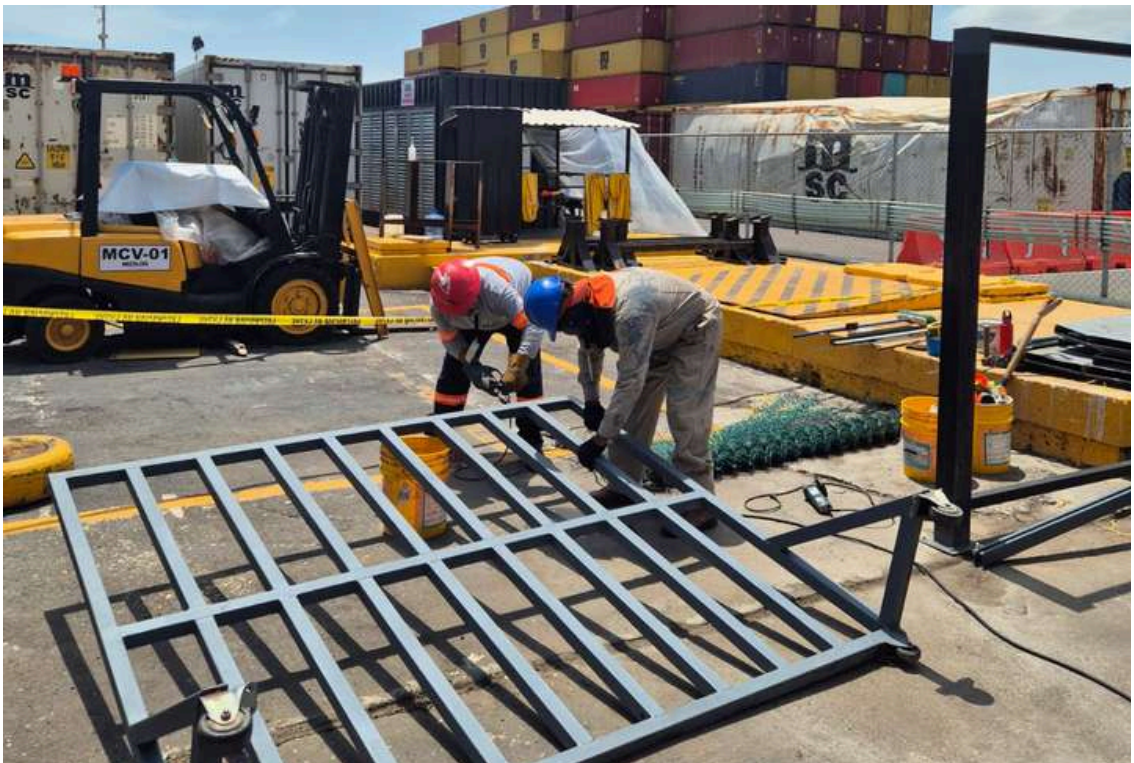
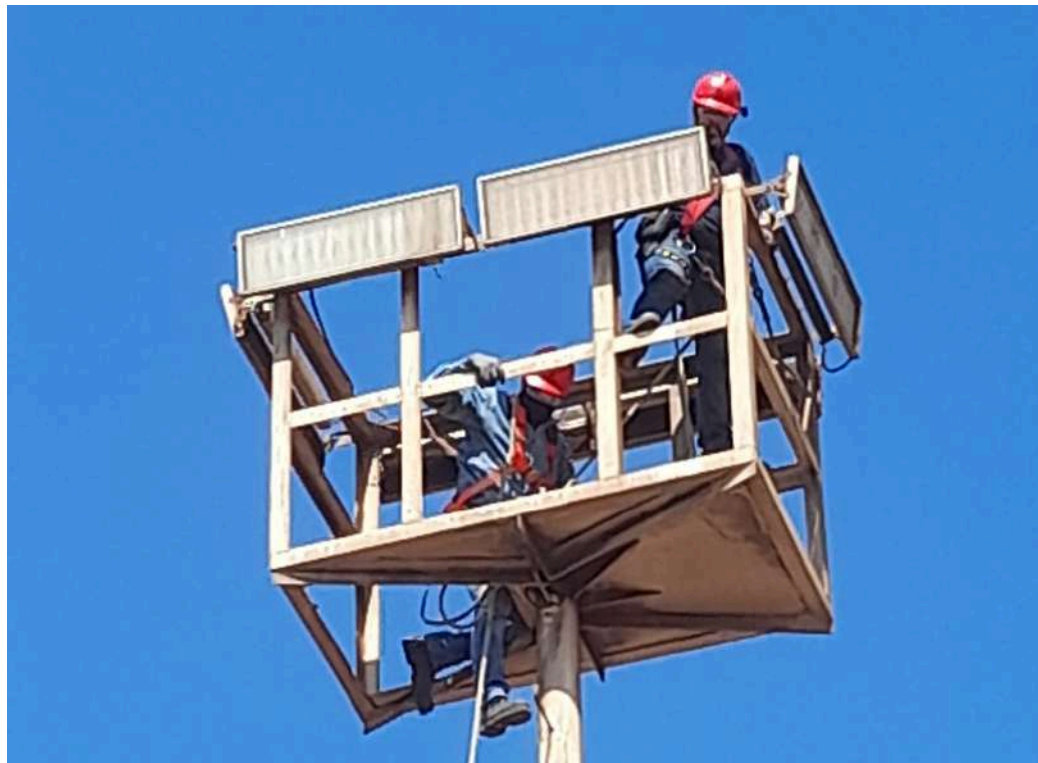



REMIVER S.A. DE C.V.

# PRINCIPALES CLIENTES



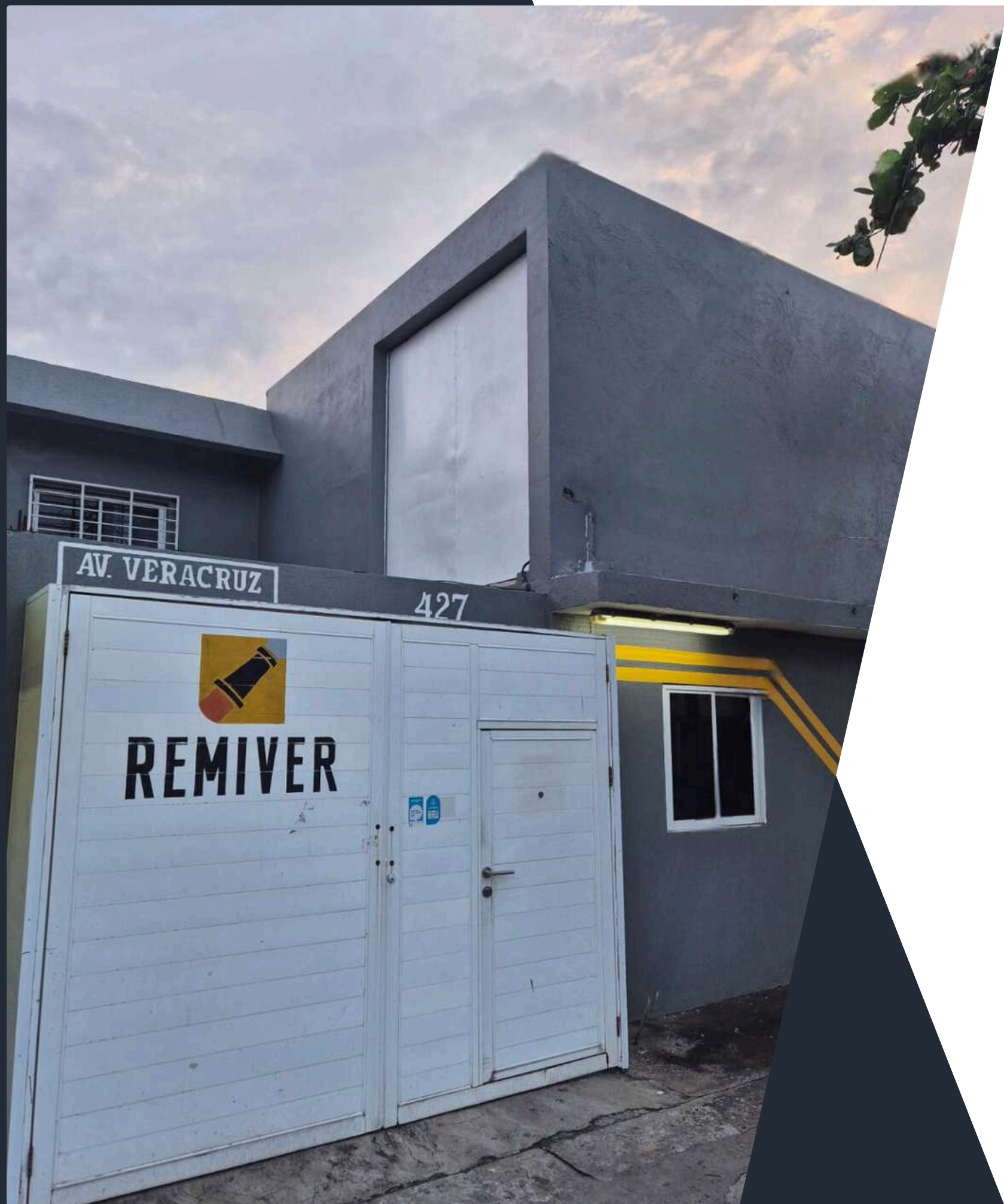

REMIVER S.A. DE C.V.

# CONTACTO

COTIZACIONES SIN COSTO



(229) 100 23 49



(229) 968 01 44



ventas@remiver.com  
direccion@remiver.com



www.remiver.com

